



miage®
by omez



Linea / Collection: IGEA

Colonna doccia / Shower column
CD F03848L.BC

Finitura / Finishing:
CROMO-BIANCO/CHROME-WHITE

Immagine / Picture



100% Made in Italy

Disegno Tecnico/ Technical Drawing

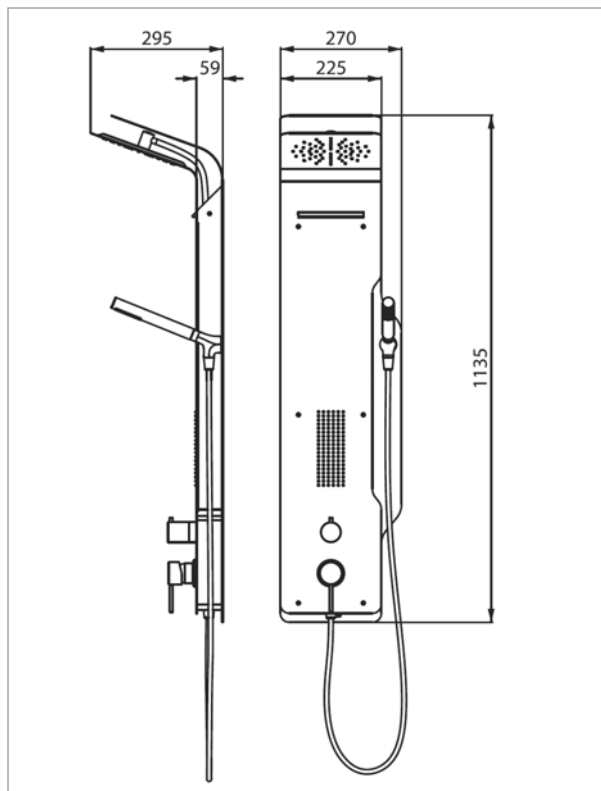

REV. 00 -2017/09/20

Descrizione / Description

Colonna doccia Igea 4 funzioni

Colonna doccia in acciaio inox lucido e verniciato, colore cromo+bianco.

4 funzioni: getto pioggia dal soffione o dalla doccia, getto relax dal soffione cascata e body jet. Funzioni con sistema anticalcare con membrana di colore GRIGIO.

Completa di: rubinetto con cartuccia per monocomando a dischi ceramici e deviatore a 4 vie cromato. Doccia Ancilla, con membrana anticalcare in colore GRIGIO e flessibile in PVC liscio cromo. Supporto doccia CON MAGNETE, regolabile in altezza.

IGEA Shower column-single lever mixer tap
Stainless-steel shower column, chrome+white colour.

4 functions: rain jet from shower head, or from hand shower, or cascade relax jet -body jet. Anti-lime scale membrane with GREY coloured nozzles. Complete with: single lever mixer cartridge tap, 4-way diverter, Ancilla hand shower and PVC flexible hose. Hand-shower support with magnet, adjustable.

Altri dettagli tecnici / Other Technical details

Diagrammi di portata / Flow rate charts

Soffione pioggia
Rain shower head

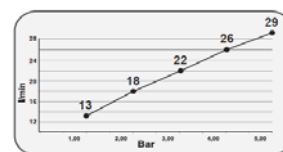

Soffione laterale
Lateral jet

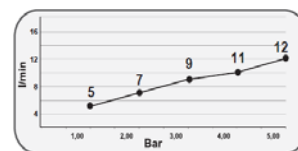

Soffione cascata
Cascade shower head

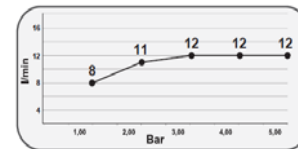

Ancilla Doccia
Ancilla Hand shower

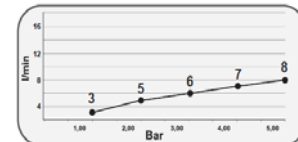

Per dettagli, istruzioni di montaggio, schede tecniche prodotto, scrivere a info@omez.net
For information about product installation and technical drawings, write to info@omez.net



miage®
by omez



Linea / Collection: IGEA

Colonna doccia / Shower column
CD F03847L.BC

Finitura / Finishing:
CROMO-BIANCO/CHROME-WHITE

Altri dettagli tecnici / Other Technical details

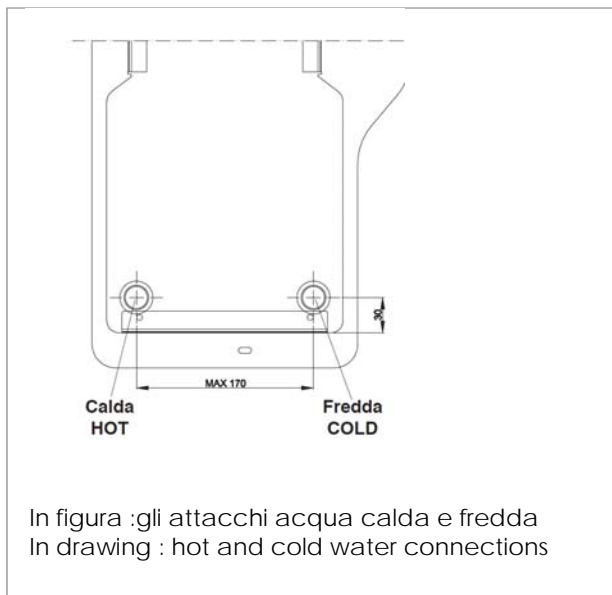

Come usare il supporto? How to use the support?

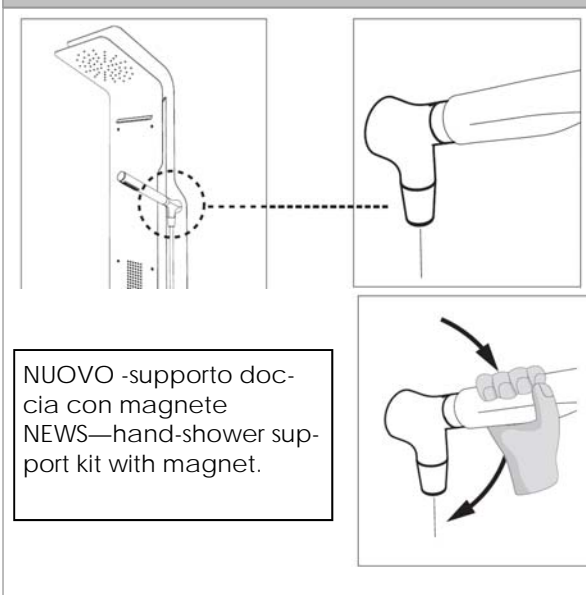

NOVITA'-NEWS AVVERTENZE per il MAGNETE— WARNINGS for MAGNET

OMEZ srl raccomanda di fare uso del supporto doccia con magnete solo per i nostri prodotti della linea Igea.



Effetto sulle persone

E' improbabile che il campo magnetico costituisca un danno per la salute, ma questo rischio non può essere del tutto escluso.

Manomissione supporto

I magneti sono trattati con rivestimento in Nichel-Rame-Nichel al fine di preservarli dalla corrosione. I supporti doccia sono stati protetti da gomma che non deve essere manomessa poichè utile per preservare integralmente la funzione del prodotto.

Resistenza al calore

I magneti hanno una temperatura massima di esercizio da 80 a 200 °C. La maggior parte dei magneti al neodimio perde in modo permanente una parte della propria forza di attrazione a una temperatura superiore a 80 °C.



Pacemaker

I magneti possono influenzare il funzionamento dei pacemaker e dei defibrillatori impiantati.

- Un pacemaker potrebbe passare automaticamente in modalità test e provocare un malore.
- Un defibrillatore potrebbe anche smettere di funzionare.
- Se siete portatori di uno di questi dispositivi, mantenete una distanza di sicurezza dal supporto doccia.



Campo magnetico

I magneti generano un campo magnetico esteso e potente. Possono danneggiare televisori, computer portatili, carte di credito e bancomat, supporti informatici, orologi meccanici, apparecchi acustici, altoparlanti e altri dispositivi.

- Tenete il supporto doccia lontano da tutti gli apparecchi e gli oggetti che potrebbero venire danneggiati da campi magnetici.

OMEZ srl recommends to make use of the magnet shower support exclusively for Igea line products.



Influence on people

According to the current level of knowledge, magnetic fields do not have a measurable positive or negative influence on people. It is unlikely that permanent magnets constitute a health risk, but it cannot be ruled out entirely.

Splintering of coating

Our shower support have a thin nickel-copper-nickel coating to protect magnet from erosion- the white rubber cap is a further protection and it must not be splintered or cracked in order to guarantee a long lasting function.

Temperature resistance

Magnets have a maximum working temperature of 80 to 200 °C. Most magnets lose part of their adhesive force permanently at a temperature more than 80 °C.



Pacemaker

Magnets could affect the functioning of pacemakers and implanted heart defibrillators.

- A pacemaker could switch into test mode and cause illness.
- A heart defibrillator may stop working.
- If you wear these devices keep sufficient distance to magnets, and warn the shower support from getting too close to these accessories.



Magnetic field

Magnets produce a far-reaching, strong magnetic field. They could damage TVs and laptops, computer hard drives, credit and ATM cards, data storage media, mechanical watches, hearing aids and speakers.

- Keep shower support away from devices and objects that could be damaged by strong magnetic fields.